

# CUBIC EVOLUTION SYSTEM SUSPENDED | G4/P4



**DE** LED-System-Pendelleuchte. Direkt-indirekt oder rein direktstrahlend. Leuchtenkörper aus Aluminiumprofil. Oberfläche naturelxiert oder weiß, graphit, schwarz bzw. champagnerfarben lackiert sowie Alu poliert. Weitere Oberflächenoptionen siehe Lightnet-Surface-Collection oder RAL nach Wahl. Microprismenoptik mit optimierter Blendungsbegrenzung speziell für Office-Anwendungen. Satinierter Opaldiffusor für Allgemeinbeleuchtung mit max. Transmissionsgrad und homogener Lichtpunktauflösung. Indirektanteil mit innovativer Linsentechnologie für breitstrahlende Deckenaufhellung. Konverter in Leuchtengehäuse integriert, wahlweise einfach schaltbar oder stufenlos dimmbar (1-10V, DALI, Touch-Dim, Casambi). Farbtemperaturen 3000K oder 4000K. Binning initial  $\leq$  MacAdam 3. Farbwiedergabe CRI>80 oder CRI>90. Stufenlos höhenverstellbare Y-Seil- oder Parallel-Seilabhängung mit transparent, rot oder schwarz ummantelter Zuleitung. Lackierung Baldachin passend Leuchtenkörper. Auf Anfrage: Integration von Notlichtkomponenten, Sensortechnologie, Zuleitungskabel in soft-touch schwarz oder rot.

**EN** LED pendant light system. Direct-indirect or direct-only light distribution. Luminaire body made of aluminium profile. Surface natural anodised or white, graphite, black or champagne coated as well as polished aluminium. Further surface options see Lightnet-Surface-Collection or RAL of your choice. Microprismatic with optimized glare reduction especially for workplaces. Satin opal diffuser for general lighting with maximum transmittance and homogeneous lighting. Indirect light with innovative lens technology for wide-angle ceiling illumination. Converter integrated into luminaire housing, optionally switchable or dimmable (1-10V, DALI, Touch-Dim, Casambi). Colour temperature 3000K or 4000K. Binning initial  $\leq$  MacAdam 3. Colour rendering CRI>80 or CRI>90. Height adjustable Y-cord suspension or parallel-cord suspension with transparent, red or black sheathed supply line. Colour of ceiling rose matching luminaire body. On request: Integration of emergency lighting components, sensor technology, soft-touch black or red sheathed supply line.

**FR** Système d'éclairage LED suspendu. Éclairage direct/indirect ou seulement direct. Corps du luminaire en profilé aluminium. Surface anodisée ou laquée blanc, graphite, noir, champagne ou polie. Autres options de finition voir Lightnet-Surface-Collection ou RAL au choix. Diffuseur microprismatique optimisé pour un éblouissement limité et adapté aux bureaux. Diffuseur opalesatiné pour un éclairage général et une transmission maximale et homogène. Composants indirects avec une technologie de lentille innovante pour un éclairage grand angle du plafond. Driver intégré dans le luminaire, au choix ON/OFF ou graduable (1-10V, DALI, Touch-Dim, Casambi). Température de couleur 3000K ou 4000K. Binning initial  $\leq$  MacAdam 3. Rendu de couleur CRI>80 ou CRI>90. Filin et tendeur rapide réglable en Y ou filin parallèle droit avec câble d'alimentation transparent, ou de matière-tissu rouge ou noir. Couleur du baldachin /patère adaptée au corps du luminaire. Sur demande: Intégration de batterie de secours, technologie de sensor/cellule, câble d'alimentation matière-tissu soft-touch noir ou rouge.

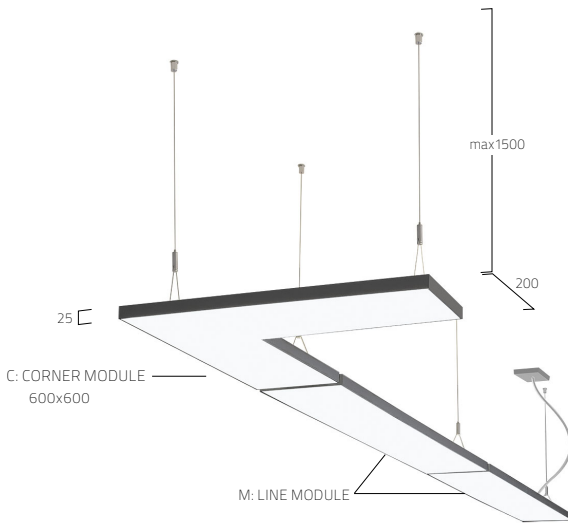

**PRODUCT-CODE:** **C P4 A B E - 8 30 M - M900 - Y**

PRODUCT FAMILY – **C** Cubic  
 TYPE – **P4** Suspended Direct-Indirect  
           **G4** Suspended Direct Only  
 OPTICAL SYSTEM – **A** Microprismatic, **O** Opal Diffuser  
 SURFACE FINISH – **W**: Snow White, **E**: Silver Anodised, **U**: Urban Graphite,  
                       **B**: Jet Black, **H**: Champagne Silver, **P**: Polished Aluminium  
 CONTROL GEAR – **E**: On/Off, **L**: DALI, **D**: 1-10V, **H**: Touch-Dim, **C**: Casambi  
 COLOUR REND. – **8**: CRI>80, **9**: CRI>90  
 COLOUR TEMP. – **27**: 2700K, **30**: 3000K, **35**: 3500K, **40**: 4000K  
 POWER – **M**: Medium Power, **H**: High Power  
 SHAPE – Line Module: **M900, M1200, M1500**  
           Corner Module: **C600**  
 SUSPENSION – **Y**: Y-Cord Suspension, **K**: 4-Cord Suspension  
 ON REQUEST – Emergency Module, Multisensor



MICROPRISMATIC / DIRECT-INDIRECT

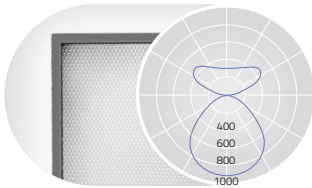

UGR $\leq$ 19 (X=4H, Y=8H, S=0.25H)  
DIRECT: ca.60% INDIRECT ca.40%

C mm	Lumen/Watt Medium Power	Lumen/Watt High Power
600x600	4070lm/35W	5110lm/45W

MICROPRISMATIC / DIRECT

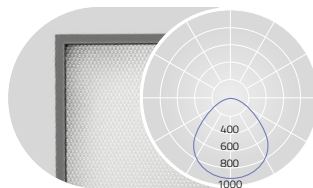

UGR $\leq$ 19 for Medium Power (X=4H, Y=8H, S=0.25H)  
DIRECT: 100%

C mm	Lumen/Watt Medium Power	Lumen/Watt High Power
600x600	2410lm/22W	3060lm/29W

OPAL DIFFUSER / DIRECT-INDIRECT

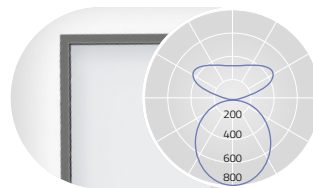

DIRECT: ca.60% INDIRECT ca.40%

C mm	Lumen/Watt Medium Power	Lumen/Watt High Power
600x600	4010lm/35W	5030lm/45W

OPAL DIFFUSER / DIRECT

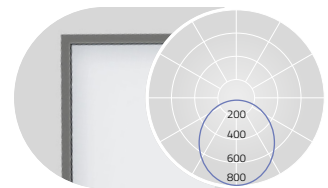

DIRECT: 100%

C mm	Lumen/Watt Medium Power	Lumen/Watt High Power
600x600	2360lm/22W	2980lm/29W

Lumen Values: Luminaire luminous flux at 4000K/CRI>80. Other configurations on request.

MICROPRISMATIC / DIRECT-INDIRECT

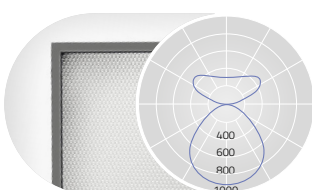

UGR $\leq$ 19 (X=4H, Y=8H, S=0.25H)  
DIRECT: ca.60% INDIRECT ca.40%

L mm	Lumen/Watt Medium Power	Lumen/Watt High Power
900	3990lm/33W	5010lm/42W
1200	5170lm/43W	6490lm/55W
1500	6400lm/53W	8000lm/68W

MICROPRISMATIC / DIRECT

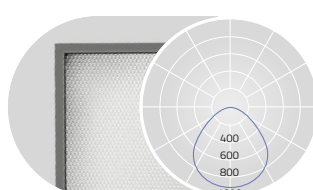

UGR $\leq$ 19 for Medium Power (X=4H, Y=8H, S=0.25H)  
DIRECT: 100%

L mm	Lumen/Watt Medium Power	Lumen/Watt High Power
900	2330lm/19W	2990lm/26W
1200	2960lm/26W	3800lm/33W
1500	3640lm/32W	4630lm/41W

OPAL DIFFUSER / DIRECT-INDIRECT

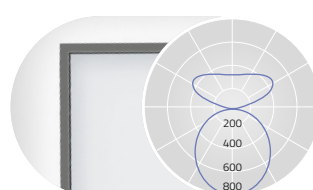

DIRECT: ca.60% INDIRECT ca.40%

L mm	Lumen/Watt Medium Power	Lumen/Watt High Power
900	3780lm/33W	4730lm/42W
1200	5000lm/43W	6240lm/55W
1500	6110lm/53W	7630lm/68W

OPAL DIFFUSER / DIRECT

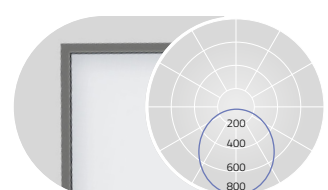

DIRECT: 100%

L mm	Lumen/Watt Medium Power	Lumen/Watt High Power
900	2120lm/19W	2710lm/26W
1200	2790lm/26W	3550lm/33W
1500	3350lm/32W	4260lm/41W

Lumen Values: Luminaire luminous flux at 4000K/CRI>80. Other configurations on request.

EDGE TO EDGE STRAIGHT CONNECTOR WITH SUSPENSION

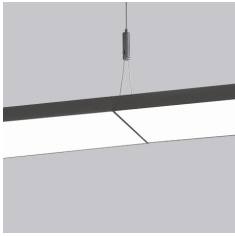

STRAIGHT CONNECTOR 20MM WITH SUSPENSION

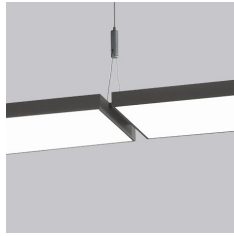

STRAIGHT CONNECTOR 300MM WITH SUSPENSION

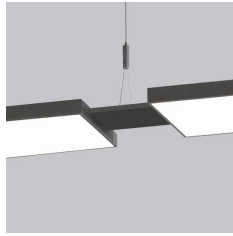

STRAIGHT CONNECTOR 500MM WITH SUSPENSION

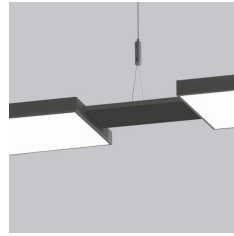

Code	Connector Length	Surface Finish	Susp. Type
S	Connector	L00	W Y
S	Connector	L20	W Y
S	Connector	L300	W Y
S	Connector	L500	W Y

CORNER CONNECTOR WITH SUSPENSION

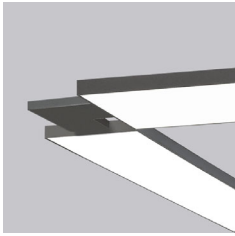

Code	Corner Length	Surface Finish	Susp. Type
C	Connector	L170X170	W Y

CANOPY + POWER SUPPLY CABLE



Code	Cable Length	Surface Finish	Cable Type
X	Canopy	L1500	W 3

SURFACE FINISH:

- W Snow White
- E Silver Anodised [Not available for Canopy]
- U Urban Graphite
- B Jet Black
- H Champagne Silver
- P Polished Aluminum [Not available for Canopy]

SUSPENSION TYPE:

- Y Y-Cord Suspension
- K 4-Cord Suspension

CABLE TYPE:

- 3 3x 0,75mm<sup>2</sup>, Transparent cable
- 5 5x 0,75mm<sup>2</sup>, Transparent cable