

MATRIC 81 MM SUSPENDED DIRECT | G5

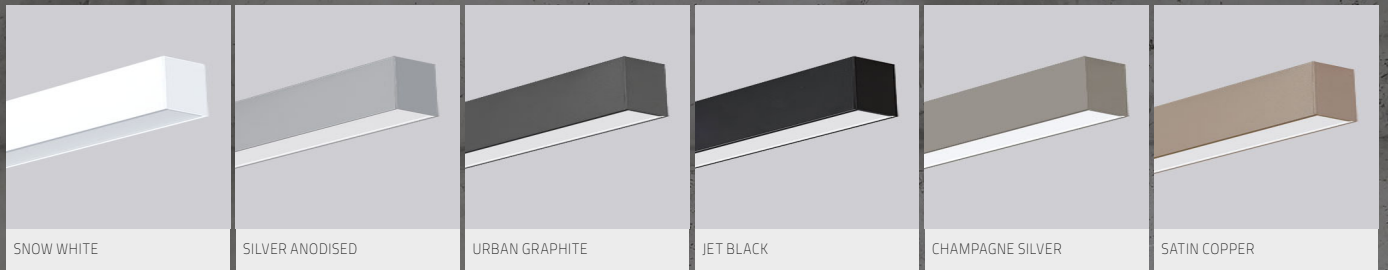
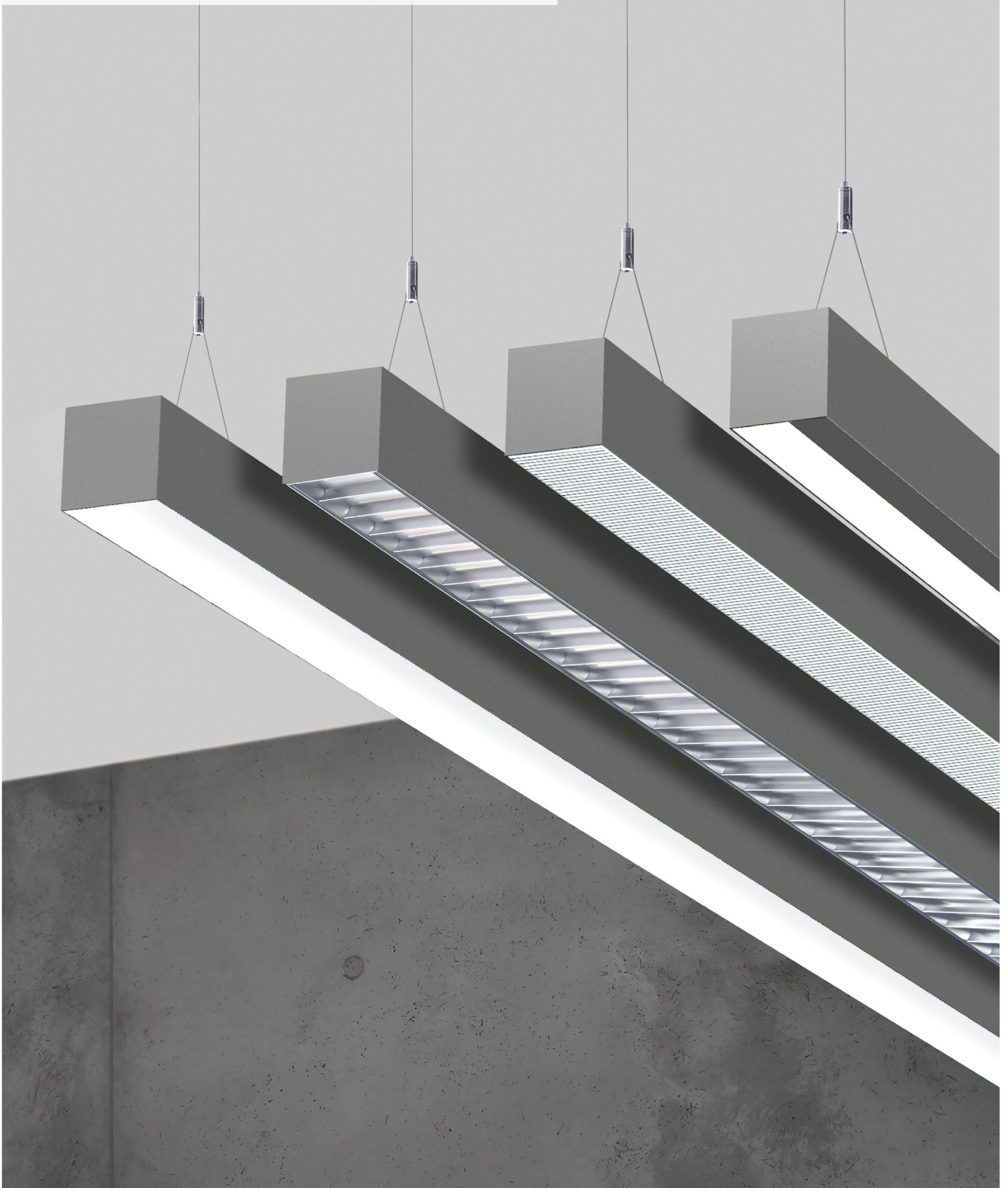

DE LED-Pendelleuchte. Rein direktstrahlend. Lichtkanal aus Aluminiumprofil mit 81mm Lichtspur-Breite. Millimetergenaue Längenfertigung nach Vorgabe möglich. Oberfläche naturelxiert oder weiß, graphit, schwarz, champagner oder kupferfarben lackiert. Weitere Oberflächenoptionen siehe Lightnet-Surface-Collection oder RAL nach Wahl. Microprismenoptik und Satin-Louver mit optimierter Blendungsbegrenzung speziell für Office-Anwendungen. Opaldiffusor aus saftigtem Acrylglas für Allgemeinbeleuchtung. Wallwasher für homogene vertikale Beleuchtung. Konverter in Leuchtgehäuse integriert, wahlweise einfach schaltbar oder stufenlos dimmbar (1-10V, DALI, Touch-Dim, Casambi). Farbtemperaturen 2200K, 2700K, 3000K, 3500K, 4000K oder 6500K. Binning initial \leq MacAdam 3. Farbwiedergabe CRI>80 oder CRI>90. Stufenlos höhenverstellbare Y-Seilabhängung mit transparent ummantelter Zuleitung. Auf Anfrage: Integration von Notlichtkomponenten, Sensortechnologie sowie Vielzahl weiterer Optionen.

EN LED pendant luminaire. Direct only light distribution. Light channel made of aluminium profile with 81mm track width. Precise length production according to specifications possible. Surface natural anodised or white, graphite, black, champagne or copper coated. Further surface options see Lightnet-Surface-Collection or RAL of your choice. Microprismatic and satin louver with optimized glare limitation especially for office purposes. Opal diffuser made of acrylic glass for general lighting. Wallwasher for homogeneous vertical illuminance. Converter integrated into luminaire housing, optionally switchable or dimmable (1-10V, DALI, Touch-Dim, Casambi). Colour temperatures 2200K, 2700K, 3000K, 3500K, 4000K or 6500K. Binning initial \leq MacAdam 3. Colour rendering CRI>80 or CRI>90. Height-adjustable Y-cord suspension with transparent power supply cable. On request: Integration of emergency lighting components, sensor technology as well as many other options.

FR Luminaire LED suspendu. Éclairage seulement direct. Rail lumineux en profil d'aluminium avec une largeur d'éclairage de 81mm. Fabrication au millimètre près des longueurs selon les spécifications. Surface anodisée ou laquée blanc, graphite, noir, champagne ou cuivre. Autres options de finition voir Lightnet-Surface-Collection ou RAL au choix. Diffuseur microprismatique ou Satin-Louver avec une limitation optimisée de l'éblouissement pour les postes de travail. Diffuseur opale en verre acrylique pour éclairage général. Wallwasher pour un éclairage vertical homogène. Driver intégré dans le luminaire, au choix ON/OFF ou graduable (1-10V, DALI, Touch-Dim, Casambi). Température de couleur 2200K, 2700K, 3000K, 3500K, 4000K ou 6500K. Binning initial \leq MacAdam 3. Rendu de couleur CRI>80 ou CRI>90. Suspension en Y réglable en hauteur avec câble d'alimentation transparent. Sur demande: Intégration de composants d'éclairage de secours ou de capteurs ainsi qu'une multitude d'autres options.

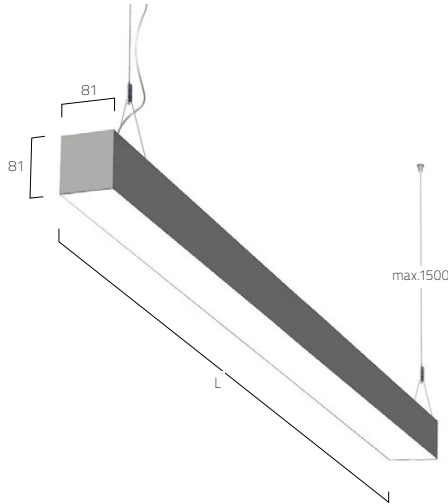

PRODUCT-CODE: L G5 A E E - 830 M - L890 - Y

PRODUCT FAMILY	L: Matric
TYPE	G5: Suspended Direct Only
OPTICAL SYSTEM	A: Microprismatic, O: Opal, M: Satin Louver, G: Wallwasher 1, J: Wallwasher 2
SURFACE FINISH	W: Snow White, E: Silver Anodised, U: Urban Graphite, B: Jet Black, H: Champagne Silver, K: Satin Copper
CONTROL GEAR	E: On/Off, L: DALI, D: 1-10V, H: Touch-Dim, C: Casambi
COLOUR REND.	8: CRI>80, 9: CRI>90, F: Full Spectrum
COLOUR TEMP.	22: 2200K, 27: 2700K, 30: 3000K, 35: 3500K, 40: 4000K, 65: 6500K
POWER	E: Low Power, M: Medium Power, H: High Power
SIZE	Luminaire length in mm: L890, L1182, L1475, L1765, L2055
SUSPENSION	Y: Y-Cord Suspension
ON REQUEST	Special Length Versions, 90°-Corner, Midpin Spotlights/Downlights, Emergency Module, Multisensor, Cable colour Red or Black



MICROPRISMATIC

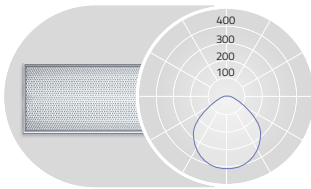

UGR \leq 19 for Low Power (X=4H, Y=8H, S=0.25H)
DIRECT 100%

OPAL

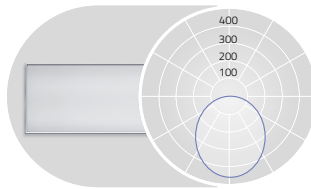

DIRECT 100%

SATIN LOUVER

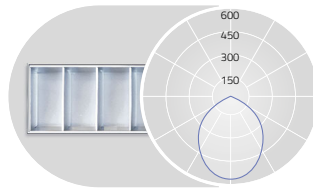

UGR \leq 19 for Medium Power (X=4H, Y=8H, S=0.25H)
DIRECT 100%

WALLWASHER 1

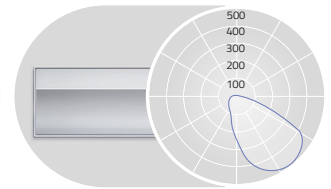

DIRECT 100%

L mm	Lumen/Watt Low Power	Lumen/Watt Medium Power	Lumen/Watt High Power
890	1620lm/14W	2470lm/21W	3280lm/29W
1182	2160lm/18W	3290lm/27W	4370lm/38W
1475	2710lm/22W	4110lm/33W	5470lm/46W
1765	3250lm/25W	4940lm/39W	6560lm/54W
2055	3790lm/29W	5760lm/45W	7650lm/61W

L mm	Lumen/Watt Low Power	Lumen/Watt Medium Power	Lumen/Watt High Power
890	1690lm/14W	2570lm/21W	3420lm/29W
1182	2260lm/18W	3430lm/27W	4560lm/38W
1475	2820lm/22W	4290lm/33W	5700lm/46W
1765	3390lm/25W	5150lm/39W	6840lm/54W
2055	3950lm/29W	6010lm/45W	7980lm/61W

L mm	Lumen/Watt Medium Power	Lumen/Watt High Power
890	1920lm/21W	2570lm/29W
1182	2550lm/27W	3430lm/38W
1475	3190lm/33W	4290lm/46W
1765	3820lm/39W	5150lm/54W
2055	4450lm/45W	6000lm/61W

L mm	Lumen/Watt High Power
890	1840lm/21W
1182	2450lm/27W
1475	3060lm/33W
1765	3670lm/39W
2055	4280lm/44W

WALLWASHER 2

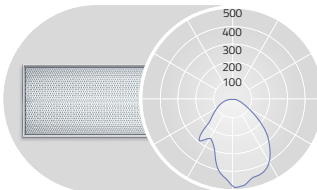

DIRECT: 100%

L mm	Lumen/Watt Medium Power	Lumen/Watt High Power
890	2320lm/21W	3080lm/29W
1182	3090lm/27W	4110lm/38W
1475	3860lm/33W	5130lm/46W
1765	4630lm/39W	6160lm/54W
2055	5410lm/45W	7180lm/61W

Lumen Values: Luminaire luminous flux at 4000K/CRI>80. Other configurations on request.

